

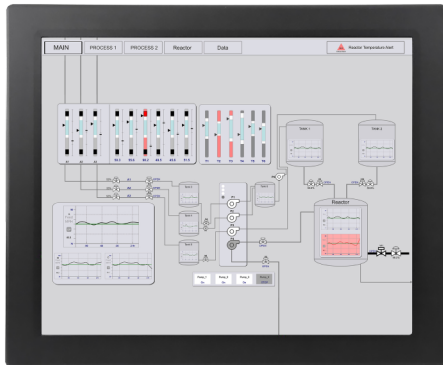

ARP-2219AP-G01-002

C1D2 Location Panel Mount Thin Client Panel PC with 19 inch 5-Wire Resistive Touch



Features

- 19" LCD, 1280 x 1024 Resolution
- 5-Wire Resistive Touch
- Aluminum or Stainless-Steel Bezel
- Intel i7-3612QM CPU
- 8GB DDR3 SO-DIMM
- Dual Gigabit Ethernet
- 2 x RS-232/422/485 BIOS Selectable
- 4 x USB 3.0, 2 x USB 2.0 ports
- ThinManager Ready

Specifications

Model Name	ARP-2219AP-G01-002
LCD Display	
Display Size (Diagonal)	19.0 inch
Resolution	1280 x 1024
Backlight Lifetime (Hours)	50,000
Visual Characteristics	
Colors	16.7 million
Aspect Ratio	5:4
Viewing Angle (V/H)	160° / 170°
Contrast Ratio	1000 : 1
Brightness	450 nits
Touchscreen	
Technology	5 Wire Resistive
Interface	USB
Driver	ThinManager Supported Driver
Front Bezel	
NEMA 4	Black Powder Coated Aluminum
NEMA 4x	Stainless Steel (Optional)
System	
CPU	Intel i7-3612QM
Chipset	Intel QM77
Memory	8GB DDR3
Video Controller	Intel HD Graphics 4000
External Video Output	DVI / HDMI / Display Port
Storage Option	N/A
CFast	N/A
Keyboard / Mouse	USB / PS2
Audio	Line in, Line Out, Mic-In
Watchdog Timer	Programmable 1 - 255 sec
Remote Boot	ThinManager Ready, PXE
Expansion Slot	1 x PCIe x16
I/O Communication	
USB Port	4 x USB 2.0, 2 x USB 3.0
Serial Port	2 x RS-232/422/485
IEEE 1394	N/A
LAN	Dual Gigabit LAN
Parallel	N/A
GPIO	N/A
Smart Battery	
External Smart Battery	N/A
OS Support	
OS Support	N/A
Power/Thermal Specs	
Power Requirement (Max)	24VDC / 3.00A
Power Consumption (Max)	72 W
Recommended Power Supply	120W
Heat Dissipation	250 BTU/hr
Physical Information	
Mounting	Panel Mount
Net Weight	25 Lbs / 11 Kg
Dimension (W x H x D)	17.80 x 14.60 x 5.71 inch 452.1 x 370.8 x 145.0 mm
Recommended Cutout Dimension (WxH)	17.00 x 13.78 inch 431.8 x 350.0 mm
IP/NEMA Rating	Bezel UL Rated Type 4X
Certification	c UL Class I Division II
Environmental	
Operating Temperature	0-50°C (32~122°F)
Storage Temperature	-20~60°C (-4~140°F)
Relative Humidity	0~95%

Dimension Drawing

ARP-2219AP-G01-002

Size Unit: inch(mm)

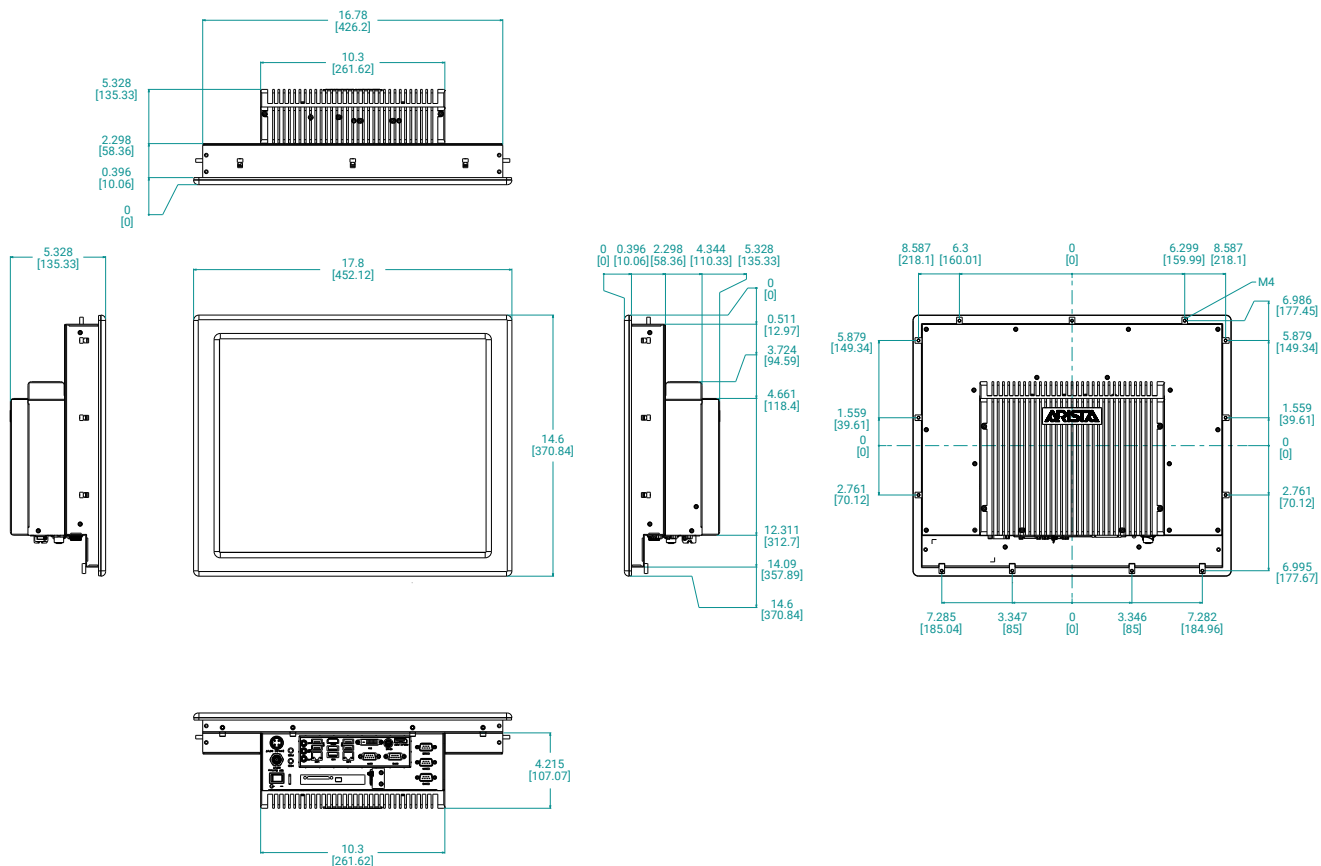

Ordering Information

Item	ARP-2219AP-G01-002-C1D2	ARP-2219AP-G01-006-C1D2
LCD Display	Standard	Standard
Touch Screen	5-Wire	5-Wire
Bezel	Black Powder Coated	Stainless Steel
CPU	i7 Mobile	i7 Mobile
Memory	8GB DDR3	8GB DDR3
Storage	N/A	N/A
ThinManager Ready	YES	YES
Power Supply	24VDC Input	24VDC Input
C1D2 Approval	YES	YES